

# Slicer 804 CCL

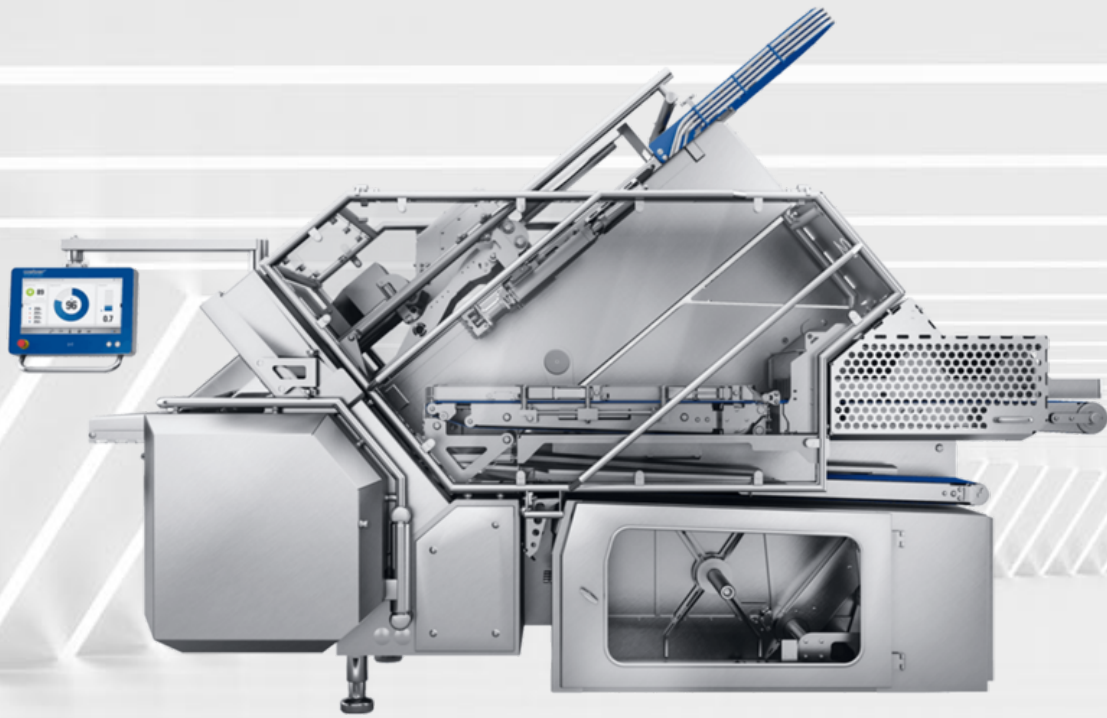

## Product details

This configuration includes:

- Slicer 804
- Transport conveyor

[View online](#)



## Advantages

 Involute blade

 Weber Hygiene Design

 Vacuum gripper

 Variogripper

 Quick set-up time

 SprayTech

















 Interleaver

 Automatic loading

# Slicer 804 CCL

Weber Slicer 804 is among the most efficient systems in its class. The involute blade system cuts products up to 1,700 mm in length at a maximum speed of 2,000 slices per minute. The automatic central operation ensures quick product changes. Slicer 804 uses a blade head with an idle cut function, which positions slice thicknesses between 0.1 millimeters and 50 millimeters precisely in various presentation forms. The 400 mm wide and 180 mm high product throat permits four 90 caliber products or three 100 x 100 products to be processed simultaneously. The system includes a program-controlled, automatically configurable product clearance height and width. The Weber hygienic design ensures that the system is easy to clean.

## Presentation

-  Stacked
-  Shingled
-  Endless-shingled
-  Circular-portion-designer
-  Multiple-overlaps - single/mixed
-  Staggered Stack
-  Shingled-with-interleave
-  Pieces
-  Oval
-  stacked-with-interleave
-  Cross-shingled
-  Shaved
-  Portion-designer
-  Shingled-stack
-  Multi-shingled
-  Folded
-  Overlapped - single/mixed



## Technical Data Slicer 804 CCL

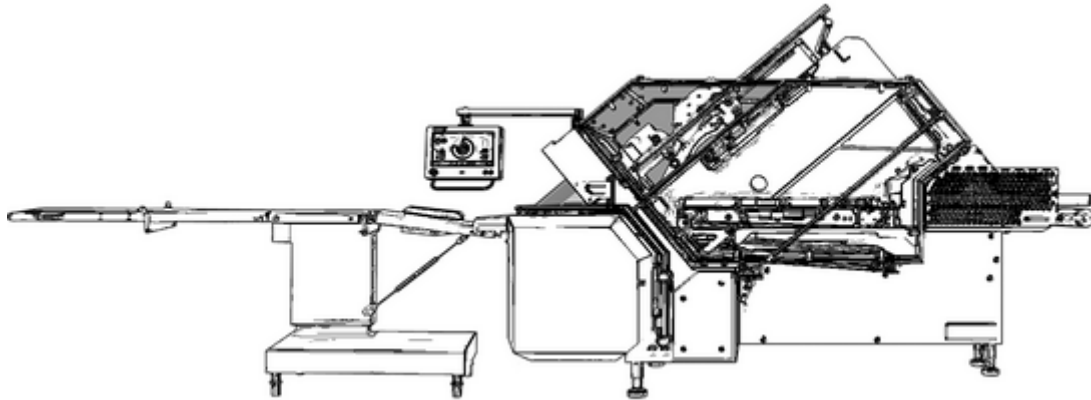

Height (mm)	2424 (with Vario grippers: 3195)
Width (mm)	1505
Length (mm)	6932
Slicing speed (rpm)	max. 2000
Product throat height (mm)	180
Product throat width (mm)	400
Product length (mm)	1200/1700
Slicing system	Involute blade
Slicing thickness (mm)	0.5-50
Loading (automatic/manual)	automatically

This document was generated automatically on 03/30/2023. All information is non-binding. We reserve the right to make changes in the interest of technical progress. For the latest information on this product, please visit:

<https://www.weberweb.com/portfolio/slicer/slicer-804/>

Weber means: service across the board.



#### Weber Academy.

**Maximize line performance through professional training courses.**

At the Weber Headquarter in Breidenbach, Germany, we have our own training center, the Weber Academy. Being a provider of complete line solutions, we offer training courses for your Weber Line, tailored precisely to your needs. In doing so, our focus is always on increasing efficiency and optimizing profit in your company.



#### Weber Guardian.

**A safe plan for your production.**

Only those who listen can understand. And those who understand can act. With our Weber Guardian program, we harmonize people, machines, and processes to get the most out of production. From preventive maintenance and inspection through targeted personnel development to production support and optimization.



#### Weber Portal.

**Networked thinking, handling together.**

You will find everything about your Weber equipment bundled in your personal Weber Portal. Compact, individual and interactive. From your customer profile and that of your machines to e-learning on your setup as well as convenient spare parts ordering and service offers. Are you already registered?