

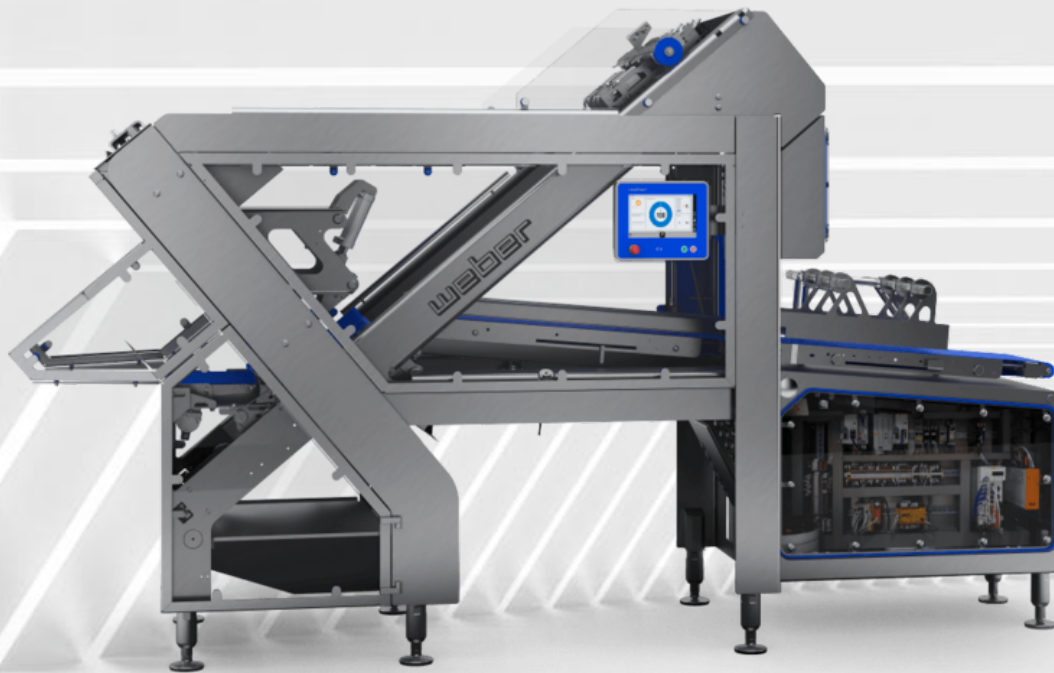

Slicer TS750

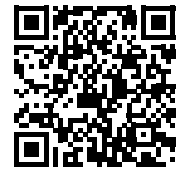

[View online](#)



Advantages

 Involute blade

 Weber Hygiene Design

 Variogripper

 Quick set-up time

 SprayTech

 Automatic loading

Slicer TS750

Application optimized, compact, powerful: The Weber Slicer TS750 is specialized on the processing of short products such as bacon or ham.

In contrast to conventional slicers, the TS750 does not convey the products to the slicing level via several conveyors connected in series. At the heart of Weber's new development, there is a new product feeding system that is impressive in its simplicity: a toothed belt drive with drivers. And, as always with Weber, in a simple and extremely compact design.

GripnGo reloading function

VarioFeed Product Feeder

ContiFlow - Slicing without reloading gaps

The TS750 comes in a variety of configurations: from a very simple version for endless slicing to high performance applications including product scanner and true dual line capability.

Presentation



Stacked



Staggered Stack



Shingled



Cross-shingled



Multi-shingled



Endless-shingled



Pieces



Shaved



Folded



Overlapped -
single/mixed

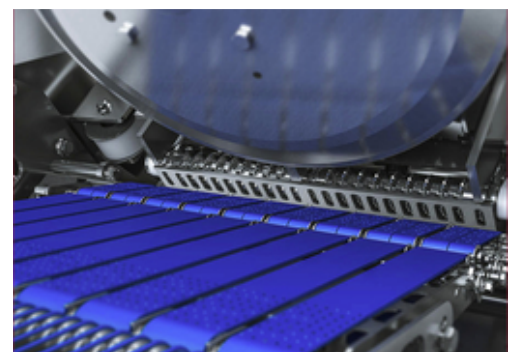

Technical Data Slicer TS750

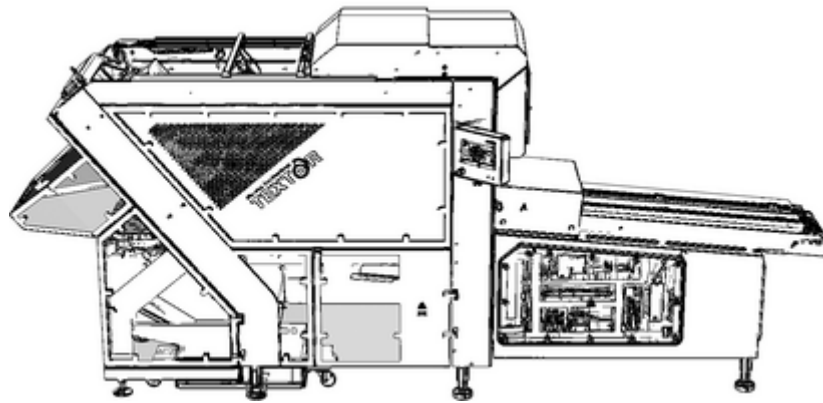

Product throat width (mm)	450 - 500
Slicing system	Involute blade system
Involute blade cutting speed (rpm)	max. 1850

This document was generated automatically on 03/30/2023. All information is non-binding. We reserve the right to make changes in the interest of technical progress. For the latest information on this product, please visit:

<https://www.weberweb.com/portfolio/slicer/slicer-ts750/>

Weber means: service across the board.



Weber Academy.

Maximize line performance through professional training courses.

At the Weber Headquarter in Breidenbach, Germany, we have our own training center, the Weber Academy. Being a provider of complete line solutions, we offer training courses for your Weber Line, tailored precisely to your needs. In doing so, our focus is always on increasing efficiency and optimizing profit in your company.



Weber Guardian.

A safe plan for your production.

Only those who listen can understand. And those who understand can act. With our Weber Guardian program, we harmonize people, machines, and processes to get the most out of production. From preventive maintenance and inspection through targeted personnel development to production support and optimization.



Weber Portal.

Networked thinking, handling together.

You will find everything about your Weber equipment bundled in your personal Weber Portal. Compact, individual and interactive. From your customer profile and that of your machines to e-learning on your setup as well as convenient spare parts ordering and service offers. Are you already registered?